

Aggregation and Concatenation in IEEE 802.16j Mobile Multihop Relay (MMR) Networks

Zhifeng Tao, Koon Hoo Teo, Jinyun Zhang

TR2007-019 April 2007

Abstract

The new mobile multi-hop relay-based (MMR) network architecture imposes a demanding performance requirement on relay stations. These relays will functionally serve as an aggregating point on behalf of the BS for traffic collection from and distribution to the multiple MSs associated with them, and thus naturally incorporate a notion of traffic aggregation. However, the packet construction mechanism in IEEE 802.16/16e standard, which was designed for handling traffic solely on a per-connection basis, cannot apply on the relay link directly, as it may render a potential bottleneck and preponderantly limit the overall network capacity. As a solution, we propose two new efficiency-improvement schemes at the MAC layer, namely MPDU concatenation and MSDU aggregation, both of which incarnate the inherent notion of aggregation and alleviate the dismal efficiency degradation on the relay links. As confirmed by the performance evaluation, the proposed concatenation and aggregation schemes can achieve significant overhead reduction, and thus better prepare the 802.16e protocol for its adoption in MMR network.

IEEE Mobile WiMAX Symposium 2007

This work may not be copied or reproduced in whole or in part for any commercial purpose. Permission to copy in whole or in part without payment of fee is granted for nonprofit educational and research purposes provided that all such whole or partial copies include the following: a notice that such copying is by permission of Mitsubishi Electric Research Laboratories, Inc.; an acknowledgment of the authors and individual contributions to the work; and all applicable portions of the copyright notice. Copying, reproduction, or republishing for any other purpose shall require a license with payment of fee to Mitsubishi Electric Research Laboratories, Inc. All rights reserved.

Aggregation and Concatenation in IEEE 802.16j Mobile Multihop Relay (MMR) Networks

Zhifeng Tao, Koon Hoo Teo, Jinyun Zhang
Mitsubishi Electric Research Laboratories
201 Broadway
Cambridge, MA 02139
Email: {tao, teo, jzhang}@merl.com

Abstract—The new mobile multi-hop relay-based (MMR) network architecture imposes a demanding performance requirement on relay stations. These relays will functionally serve as an aggregating point on behalf of the BS for traffic collection from and distribution to the multiple MSs associated with them, and thus naturally incorporate a notion of "traffic aggregation". However, the packet construction mechanism in IEEE 802.16/16e standard, which was designed for handling traffic solely on a per-connection basis, cannot apply on the relay link directly, as it may render a potential bottleneck and preponderantly limit the overall network capacity. As a solution, we propose two new efficiency-improvement schemes at the MAC layer, namely MPDU *concatenation* and MSDU *aggregation*, both of which incarnate the inherent notion of "aggregation" and alleviate the dismal efficiency degradation on the relay links. As confirmed by the performance evaluation, the proposed concatenation and aggregation schemes can achieve significant overhead reduction, and thus better prepare the 802.16e protocol for its adoption in MMR network.

I. INTRODUCTION

Due to significant loss of signal strength along the propagation path for certain spectrum, the coverage area of IEEE 802.16/16e is often of limited geographical size. In addition, blocking and random fading frequently result in areas of poor reception or even dead spot within the coverage region. Conventionally, this problem has been addressed by deploying BSs in a denser manner. However, the high cost of BSs and potential aggravation of interference, among others, render this approach less desirable. As an alternative, a relay-based approach can be pursued, wherein low cost relay stations (RS) are introduced into the network to help extend the range, improve service, and eliminate dead spots, all in a cost-effective fashion.

In the March of 2006, the new task group 802.16j was officially established [1], which attempts to amend current IEEE 802.16e standard [2] in order to support mobile multi-hop relay (MMR) operation in the wireless broadband network.

The new mobile multi-hop relay-based (MMR) network architecture imposes a demanding performance requirement on relay stations. These relays will functionally serve as an aggregating point on behalf of the BS for traffic collection from and distribution to the multiple MSs associated with them, and thus naturally incorporate a notion of "traffic aggregation". However, the packet construction mechanism in IEEE 802.16/16e standard, which was designed for handling

traffic solely on a per-connection basis, cannot apply on the relay link directly, as it may render a potential bottleneck and preponderantly limit the overall network capacity.

In this paper, we propose new protocol mechanisms to enable aggregation and concatenation on the relay links, thereby incarnating the intrinsic notion of "aggregation" and combating potential efficiency deterioration in IEEE 802.16 MMR networks.

The rest of the paper is organized as follows. A brief description of current IEEE 802.16e OFDMA protocol [2] and its deficiency is provided in Section II, aiming to supply necessary background and motivate the ensuing discussion. The new MAC protocol data unit (MPDU) *concatenation* and MAC service data unit (MSDU) *aggregation* schemes are then elaborated in Section III and IV, respectively. The performance evaluation results are presented in Section V, followed by the conclusion and future work in Section VI, which completes the paper.

II. BACKGROUND AND MOTIVATION

IEEE 802.16-2004 has adopted orthogonal frequency-division multiple access (OFDMA) as the primary channel access mechanism for non-line-of-sight (NLOS) communications in the frequency bands below 11 GHz, wherein separate sets of orthogonal tones are allocated to multiple users so that these users can engage in communication in parallel. The basic unit of resource for allocation is a *slot*, which is comprised of a number of OFDMA symbols in time domain, and one subchannel in frequency domain. The base station divides the timeline into contiguous *frames*, each of which further consists of a downlink (*DL*) and an uplink (*UL*) *subframe*. As illustrated in Figure 1, a DL subframe starts with a preamble, which helps MSs perform synchronization and channel estimation. In the OFDMA symbol that immediately follows the preamble, BS transmits a downlink MAP (DL-MAP) and an uplink MAP (UL-MAP) message to notify MSs of the corresponding resources allocated to them in the DL and UL direction, respectively, within the current frame. Based upon the schedule received from the BS, each MS can determine when (i.e., OFDMA symbols) and where (i.e., subchannels) should it receive from and transmit to BS. Corresponding time gap (e.g., TTG and RTG) is inserted between two consecutive subframes, in order to give wireless device sufficient time to

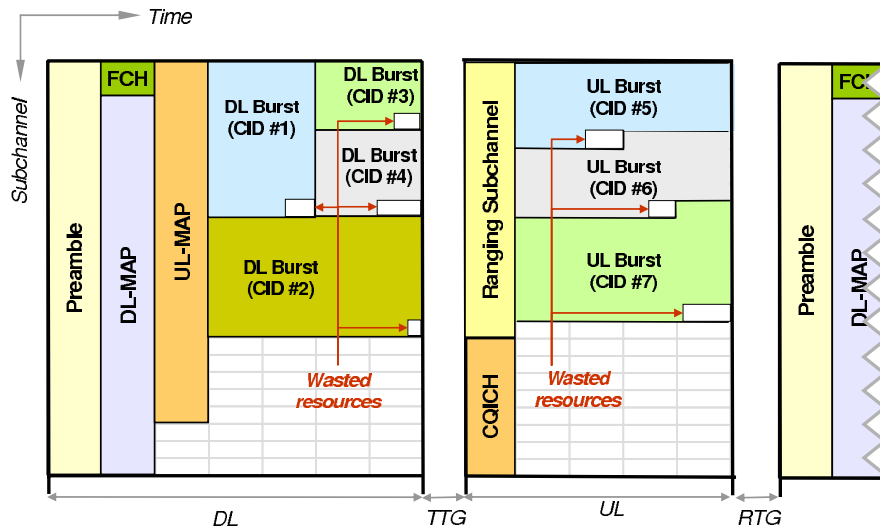

Fig. 1: Current OFDMA frame structure and potential problem

switch from the transmission mode to reception mode, or vice versa.

A key concept in IEEE 802.16 is connection, which according to the IEEE 802.16 standard [3], is a unidirectional mapping established and maintained between BS and MS medium access control (MAC) peers for the purpose of transporting a service flow's traffic. All traffic is carried on connections, even for service flows that implement connectionless protocols (i.e., IP).

In the current point-to-multipoint (PMP) network topology, resource allocation is performed by BS on a per connection basis, and all the MSs are treated more or less equally. This is a sensible design for a single-hop PMP network, but by no means the most efficient one. Indeed, it has already been shown in [4] [5] that as the number of connections increases, the overhead entailed thereby can cost as much as over 50% MAC efficiency degradation. The primary culprits of the performance deterioration are twofold:

- **Data plane**

Usually, the resource allocated to each individual connection cannot be fully consumed, because the actual data bits do not map exactly to the assigned OFDMA symbols and subchannels. Due to this *mapping inefficiency*, variable number of padding bits will be appended at the end of the last data bit, leading to resources waste as depicted in Figure 1.

- **Management plane**

In the current management plane, one downlink MAP information element (DL_MAP_IE) normally contains the schedule for one connection only. This design becomes cumbersome and inefficient as the number of connections grows large.

The aforementioned problem is exacerbated when the current IEEE 802.16e OFDMA protocol is applied on the relay link between a BS and a RS, or between a pair of RSs [6], as significant number of connections will be aggregated therein.

To curb the waste and improve the performance of current

IEEE 802.16e protocol on relay links, we propose an MPDU concatenation scheme in Section III, which directly addresses the problem in the data and management planes. In addition, we also introduce a new MSDU aggregation mechanism in Section IV, intending to complement the highly restrictive *packing* mechanism defined in the current 802.16.

III. MPDU CONCATENATION

IEEE 802.16 [3] has defined an operation called *concatenation*, whereby multiple MPDUs can be concatenated into a single transmission burst in either uplink or downlink direction, regardless of whether these MPDUs are belonging to the same connection or not. In essence, IEEE 802.16 concatenation is equivalent to an aggregation at MPDU level.

IEEE 802.16e [2] has further extended the DL_MAP_IE of legacy IEEE 802.16 [3] in order to carry the identifiers of multiple connections (CIDs) in a single information element (IE). Figure 2(a) shows the format of the DL_MAP_IE and highlights the related extension introduced in IEEE 802.16e.

The last missing link to enabling efficient MPDU concatenation on relay link is the capability of supporting multiple connections using one uplink information element. In the uplink, allocations for regular data traffic are specified as duration in slots, whereas the starting point for allocation is determined based upon the prior allocation appearing in the UL-MAP. Since IEEE 802.16j requires that no change can be made at any MS, the UL_MAP_IE thus shall be modified in such a fashion that legacy MSs are still able to derive their own assigned schedule based on the new UL_MAP_IE.

Thus, we propose to extend the UL_MAP_IE for relay link as portrayed in Figure 2(b) and 2(c), where the support to multiple connections can be accomplished while backward compatibility is also maintained. For the sake of brevity, all the ensuing discussions apply for communications occurring on relay links only, unless otherwise noted.

Whenever a relay station deems appropriate and necessary, it can aggregate a set of connections of the same QoS requirement from multiple MSs into a single logical connection. To

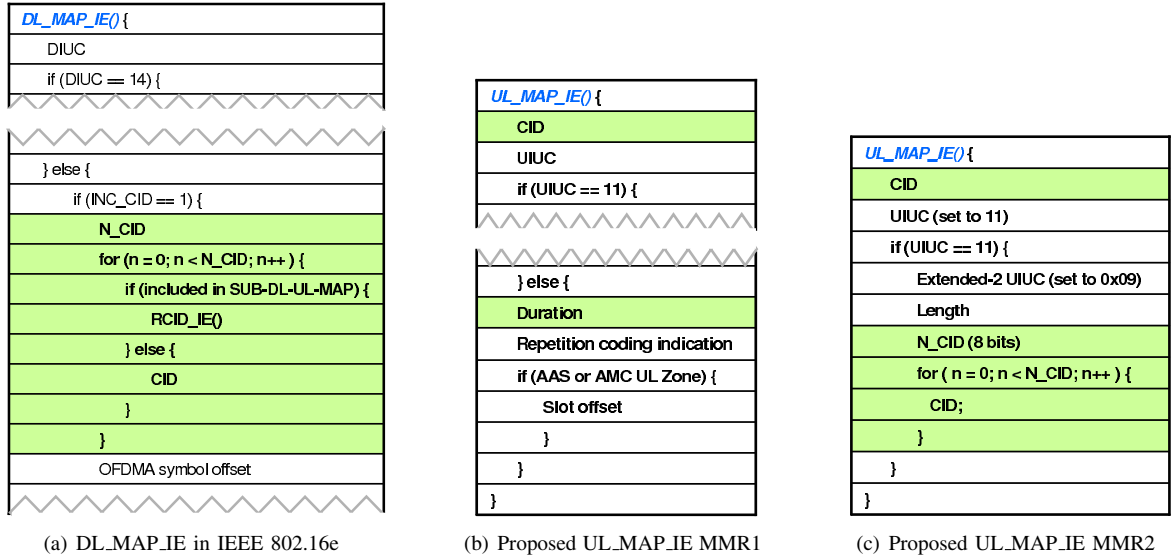

Fig. 2: Format of MAP information element (MAP_IE)

convey resource allocation information associated with this set of connections, the UL_MAP_IE MMR1 shown in Figure 2(b) should appear first in the UL-MAP message. Its *CID* field contains the identifier of the corresponding new logical connection established on the relay link, while its *duration* covers the total resources given to all the connections belonging to this logical set. All the MSs that communicate with the BS directly can still understand the UL_MAP_IE MMR1, and thus calculate the starting point of the resource given to itself. The UL_MAP_IE MMR1 should be followed by UL_MAP_IE MMR2 immediately, which indicates the identifier of all the individual connections that the preceding UL_MAP_IE MMR1 covers. Since UL_MAP_IE MMR2 follows the *UL-MAP extended-2 IE* format specified in IEEE 802.16e, all the legacy MSs simply skip this information element upon reception, and thus the backward compatibility remains intact.

The newly defined UL_MAP_IE MMR 1 and UL_MAP_IE MMR 2, in conjunction with DL_MAP_IE can provide necessary and sufficient signaling support to accommodate multiple connections. Thus, MPDU concatenation initially introduced in [3] now can be enabled in the data plane to achieve higher efficiency on the relay link, as illustrated in Figure 3.

IV. MSDU AGGREGATION

Packet aggregation, as another key efficiency-improvement technique, has also found its application in a wide variety of high performance wireless standards, due to its simplicity and efficacy. One iconic example is IEEE 802.11n [7] [8], which tends to utilize packet aggregation technique at both MSDU and MPDU levels to fulfill the 100 *Mbps* requirement.

The packing mechanism defined in IEEE 802.16/16e essentially is an MSDU aggregation. However, it confines its scope to only MSDUs from the same connection. This poses a highly restrictive constraint particularly on a relay link, as MSDUs of different CIDs or even from different MSs may be transported

over a single logical connection between the BS and RS, given the connection aggregation capability described in Section III.

In order to relax the restriction imposed by legacy packing mechanism and extend the applicability of aggregation at MSDU level, we propose a new MMR aggregation subheader (MA-SH) for communication on relay link. As illustrated in Figure 4, the whole aggregated MSDU is started with a general MAC header (GMH), followed by various legacy subheaders (χ SH), MA-SH and the individual MSDU. Note that the MA-SH is inserted immediately in front of each MSDU that it is associated with. The *MA* (i.e., MMR MSDU aggregation) subfield, which once was a *reserved bit* in the generic MAC header, will be used to indicate that the current MPDU contains aggregated MSDU and the corresponding aggregation subheader (MA-SH) as well. All the new subheaders and subfields that require new interpretation have been highlighted in green in Figure 4.

It is evident that the proposed MA-SH and the generic MAC header bear appreciable resemblance. Indeed, the only subfields that MA-SH can eliminate from the generic MAC header are header checksum (HCS) and cyclic redundancy check (CRC). All other subfields have to be retained, as many configurations (e.g., security protection, encryption key, MSDU length, and CID, etc.) may vary on a per MSDU basis. It is worthwhile to note that any concern of potential compromise of reliability can be dismissed, as similar overhead reduction approach was pursued in the legacy packing scheme.

V. PERFORMANCE EVALUATION

In order to compare the performance of the legacy 802.16e and the proposed MPDU concatenation and MSDU aggregation mechanisms, MAC protocol efficiency Eff and efficiency improvement Eff_+ defined in Equation 1 will be used as primary metrics.

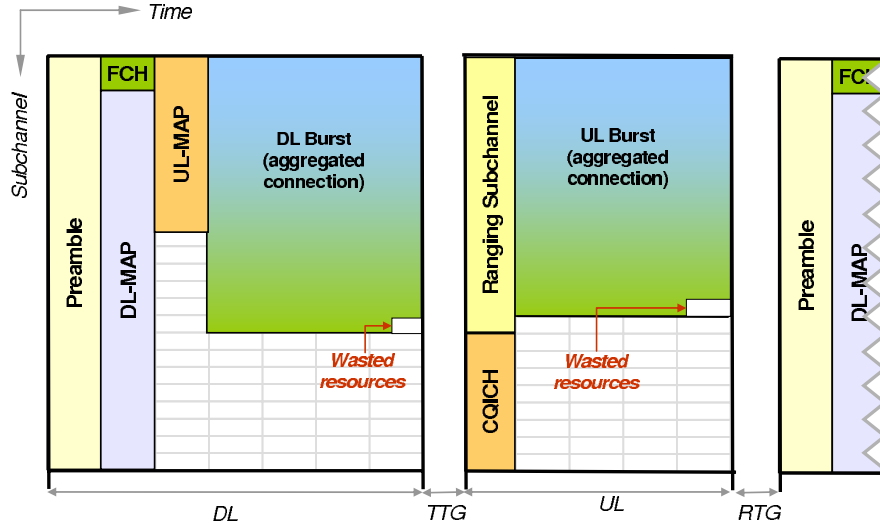

Fig. 3: OFDMA frame structure with proposed MPDU concatenation for 802.16j MMR

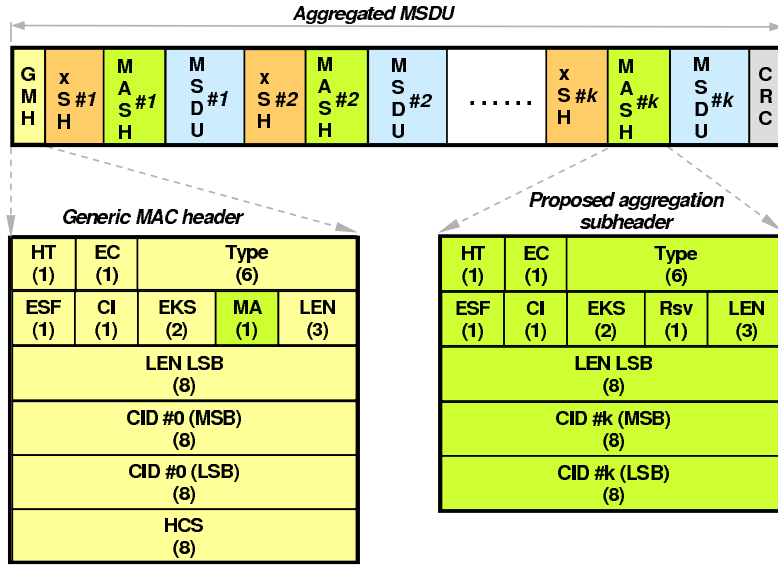

Fig. 4: Proposed MSDU aggregation

$$\begin{cases} Eff = \frac{B}{T} \times \frac{1}{R} \times 100\% \\ Eff_+ = \frac{Eff(scheme\ 1) - Eff(scheme\ 2)}{Eff(scheme\ 2)} \times 100\% \end{cases} \quad (1)$$

where B , T , and R denote the total number of MSDU bits, time to transmit these bits, and the actual physical layer transmission rate, respectively.

To concentrate on the proposed schemes, an error-free channel condition is assumed. The network under investigation only includes one BS and one RS, and all the connections are established on the relay link. Moreover, suppose each connection has infinite traffic supply, and thus always has packets to transmit during the slots assigned to it. Other key PHY and MAC parameters used in evaluation are summarized in Table I.

A. MPDU Concatenation

First of all, the size of UL-MAP message is depicted in Figure 5(a) as a function of number of connections for both the legacy IEEE 802.16e and the proposed extension of UL_MAP_IE. Evidently, the adoption of new UL_MAP_IE format always results in smaller management plane overhead, as compared to the legacy scheme. In addition, the overhead reduction becomes more pronounced, as the number of parallel connections grows. For example, the saving achieved can reach as high as 50%, when the relay station has to simultaneously support 55 connections or more.

Figure 5(b) further illustrates the relation between MAC efficiency and number of connections. It can be observed in Figure 5(b) that MPDU concatenation in conjunction with the extended UL_MAP_IE can sustain a stable MAC efficiency, while the legacy protocol yields a serious efficiency degrada-

TABLE I: Key PHY and MAC parameters

DL/UL Permutation	FFT size	Channel bandwidth	MCS (data)	MCS (MAP and preamble)	Cyclic prefix (G)
PUSC/PUSC	1024	20 MHz	64 QAM 3/4	QPSK 1/2	1/32
Sampling factor (n)	Period for UCD/DCD	Frame duration	Number of UL BW/RNG subchannels	RTG	TTG
28/25	every 10 frames	20 ms	6	10 μ s	10 μ s

tion as the number of connections grows. This highly desirable feature of insensibility is particularly indispensable for 802.16j MMR network, as the relay links will experience magnitude of increase in the number of connections.

Figure 5(c) and 5(d) portray the same relation as Figure 5(b), but focus on MPDUs of smaller size (i.e., 500 and 100 bytes). A simple comparison between these three figures suggests that both the MAC efficiency and the corresponding improvement enabled by the proposed MPDU concatenation heavily rely on the packet size. A closer examination of the performance results reveals that as the MPDU size decreases, it becomes more likely to occupy most of the allocated slots by fitting in small packets, thereby lowering the waste caused by *mapping inefficiency* to a lesser but still appreciable level.

B. MSDU aggregation

Given the non-negligible impact of packet size, the performance of MSDU aggregation is evaluated with a wide variety of MSDU length, as shown in Figure 6. More specifically, Figure 6(a) compares the MAC efficiency improvement (Eff_+) achieved by packing and MSDU aggregation, and indicates that both schemes are most effective in the short packet region, which is consistent with the finding made in [5]. Moreover, due to the fact that MSDU aggregation preserves many subfields of generic MAC header in order to accommodate connections of different configurations, the overhead reduction it can thus accomplish is lower than packing.

An empirical packet size distribution plotted in Figure 6(b) [9] is used to further evaluate MSDU aggregation in a more realistic environment. The traffic collected in [9] assumes a bimodal pattern, where packets generated by MAC management/control and TCP handshake (≤ 200 bytes) and by Ethernet data (= 1500 bytes) dominate. Although the distribution is specifically for IEEE 802.11 WLAN traffic, it is reasonable to assume that similar pattern also applies for IEEE 802.16e traffic.

Under the empirical traffic model, the efficiency improvement reaped in by MSDU aggregation is on average approximately 66% of that by packing mechanism. On the other hand, the proposed MSDU aggregation enjoys a much wider applicability than the legacy packing, as it can handle MSDUs of different CIDs. Therefore, the two schemes are recommended to be deployed together on the relay links, thanks to their complementary nature.

VI. CONCLUSION AND FUTURE WORK

In this paper, we have proposed two efficiency-improvement schemes, namely MPDU concatenation and MSDU aggrega-

tion, to leverage the inherent notion of "aggregation" on the relay links, and improve the preparedness of IEEE 802.16e protocol for adoption in an 802.16j mobile multi-hop relay network. The performance evaluation results further confirm that the MPDU concatenation and UL_MAP_IE extension can sustain a stable protocol efficiency, and avoid the dismal degradation that plagues the legacy IEEE 802.16e. In addition, the MSDU aggregation scheme extends the applicability of aggregation from MSDUs of same CID value to those of identical QoS requirement, yet still delivers an efficiency improvement on par with packing. As a conclusion, the MPDU concatenation, MSDU aggregation and packing can work altogether to provide a comprehensive efficiency-improvement solution for application on relay links.

Regarding the future work, it is worthwhile to evaluate the impact of the proposed aggregation schemes on actual system capacity and delay performance. In addition, the effect of channel error also deserves a more detailed investigation. Finally, a more profound understanding of the influence that scheduling and OFDMA symbol mapping algorithms may exert shall also be established.

REFERENCES

- [1] "IEEE 802.16j Mobile Multihop Relay Project Authorization Request (PAR)," *Official IEEE 802.16j Website*: <http://standards.ieee.org/board/nep/projects/802-16j.pdf>, March 2006.
- [2] "IEEE Standard for Local and Metropolitan Area Networks – Part 16: Air Interface for Fixed Broadband Wireless Access Systems, Amendment 2: Physical and Medium Access Control Layers for Combined Fixed and Mobile Operation in Licensed Bands," *IEEE Computer Society and the IEEE Microwave Theory and Techniques Society*, February 2006.
- [3] "IEEE Standard for Local and Metropolitan Area Networks – Part 16: Air Interface for Fixed Broadband Wireless Access Systems," *IEEE Computer Society and the IEEE Microwave Theory and Techniques Society*, October 2004.
- [4] S. Redana, M. Lott, and A. Capone, "Performance evaluation of point-to-multi-point (PMP) and mesh air-interface in IEEE standard 802.16a," in *Proceedings of IEEE 60th Vehicular Technology Conference (VTC 2004-Fall)*, (Los Angeles, CA), September 2005.
- [5] A. E. Xhafa, S. Kangude, and X. Lu, "MAC performance of IEEE 802.16e," in *Proceedings of IEEE 62nd Vehicular Technology Conference (VTC 2005-Fall)*, (Dallas, Texas), September 2005.
- [6] "Harmonized definitions and terminology for 802.16j Mobile Multi-hop Relay," *IEEE 802.16j-06/014r1* <http://www.ieee802.org/16/relay/index.html>, October 2006.
- [7] "IEEE P802.11n D1.05 - Draft Amendment to Standard for Local and Metropolitan Area Networks - Part 11: Wireless LAN Medium Access Control (MAC) and Physical Layer (PHY) specifications," October 2006.
- [8] Y. Xiao, "Packing mechanisms for the IEEE 802.11n wireless LANs," in *Proceedings of IEEE Global Telecommunications Conference*, (Dallas, Texas), November 2004.
- [9] J. Yeo, M. Youssef, and A. Agrawala, "Characterizing the IEEE 802.11 Traffic: The Wireless Side," *Technical report, Department of Computer Science, University of Maryland*, March 2004, <http://www.cs.umd.edu/~moustafa/papers/CS-TR-4570.pdf>.

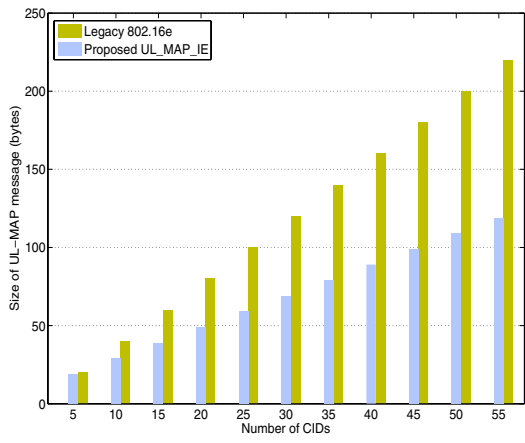

(a) Size of UL-MAP message

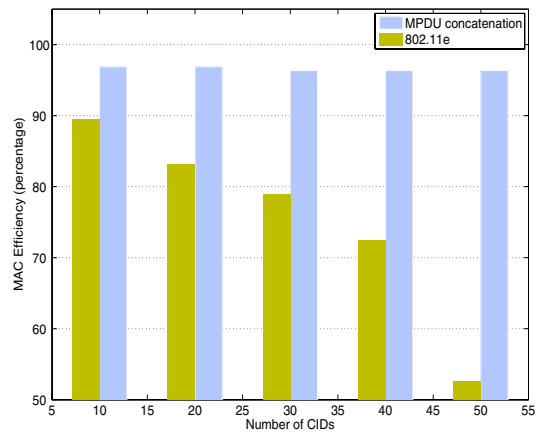

(b) MAC efficiency (MPDU = 1000 bytes)

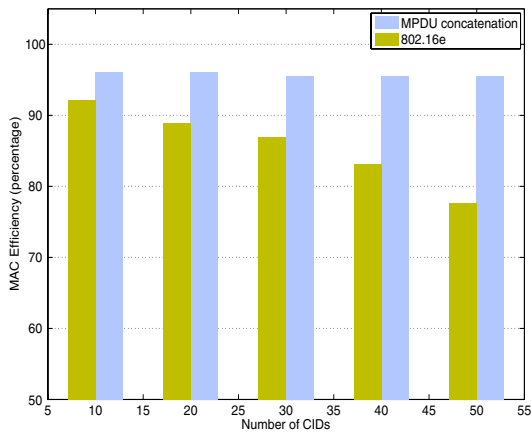

(c) MAC efficiency (MPDU = 500 bytes)

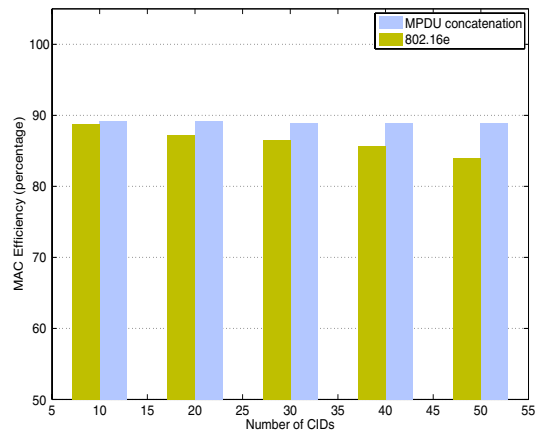

(d) MAC efficiency (MPDU = 100 bytes)

Fig. 5: Performance of MPDU concatenation

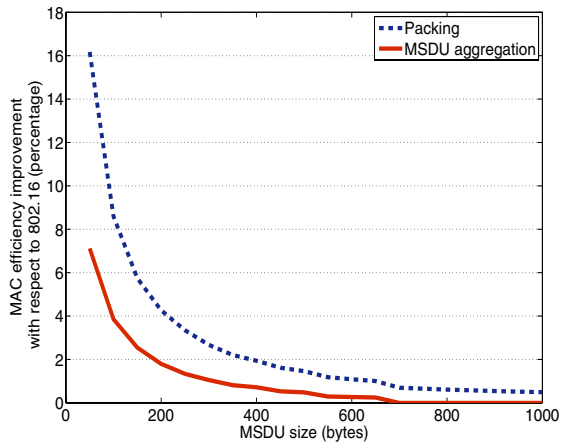

(a) With constant packet size

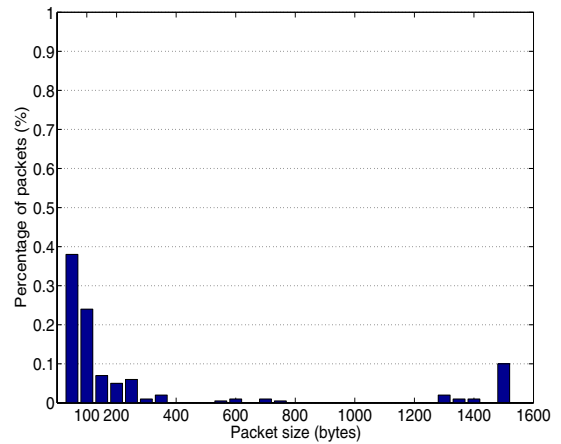

(b) Empirical packet size distribution (IEEE 802.11)

Fig. 6: Performance of MSDU aggregation